

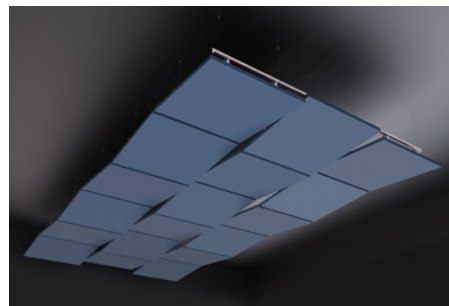

Sonify Create

Installation Guide

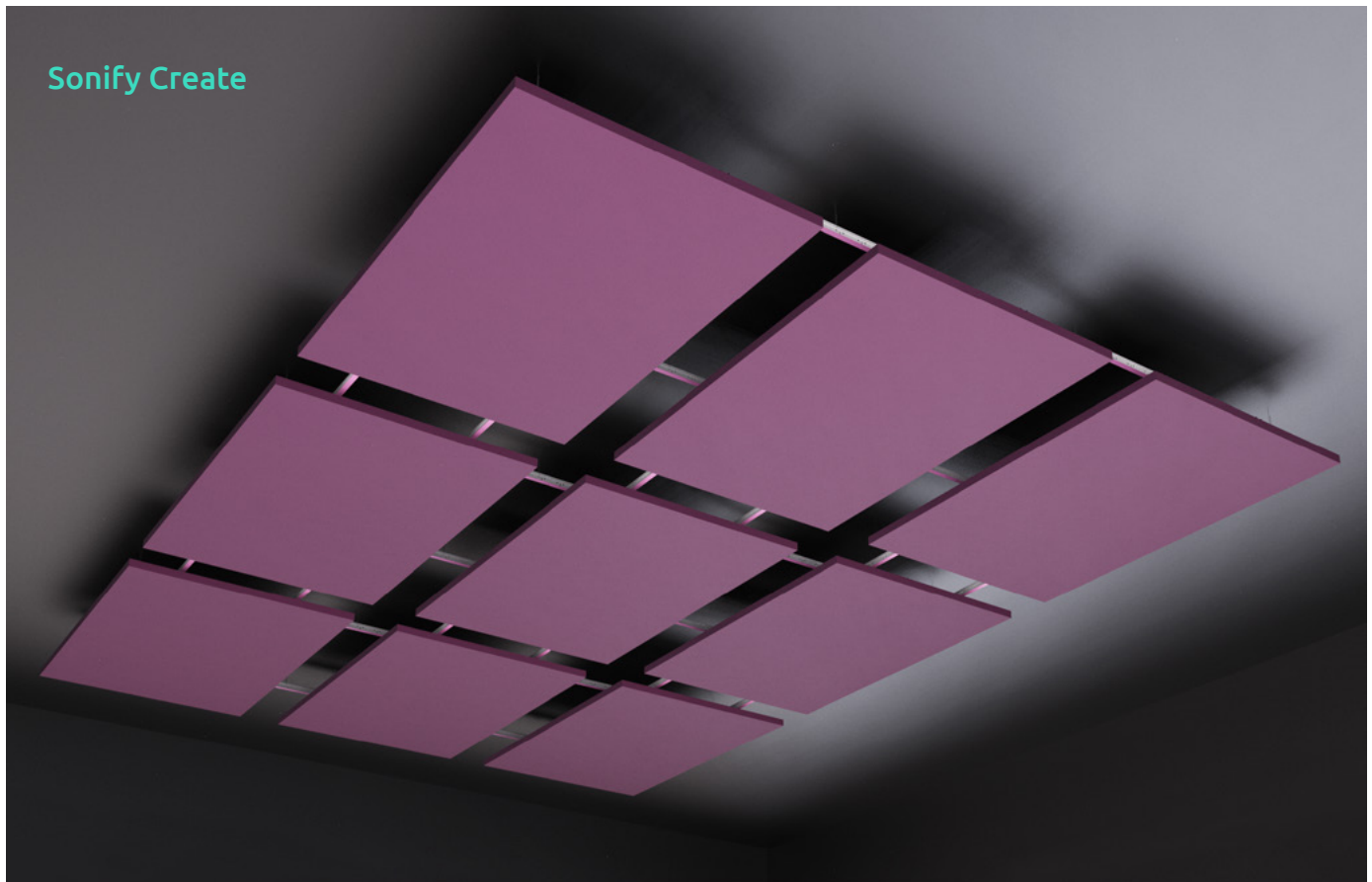



First time using Sonify?

The Sonify Create grid system is designed to reduce the amount of drilling and measuring on site. Once the first steps are completed accurately, it always ensures perfect alignment, identical spacing and even heights throughout the whole installation, thanks to its 100mm grid logic. This allows you to save time while installing highly aesthetic and functional acoustic ceiling elements.

This is a generic installation guide. For details about your individual installation please refer to the specification documents provided by your specifier.

02 Sonify Create Components*

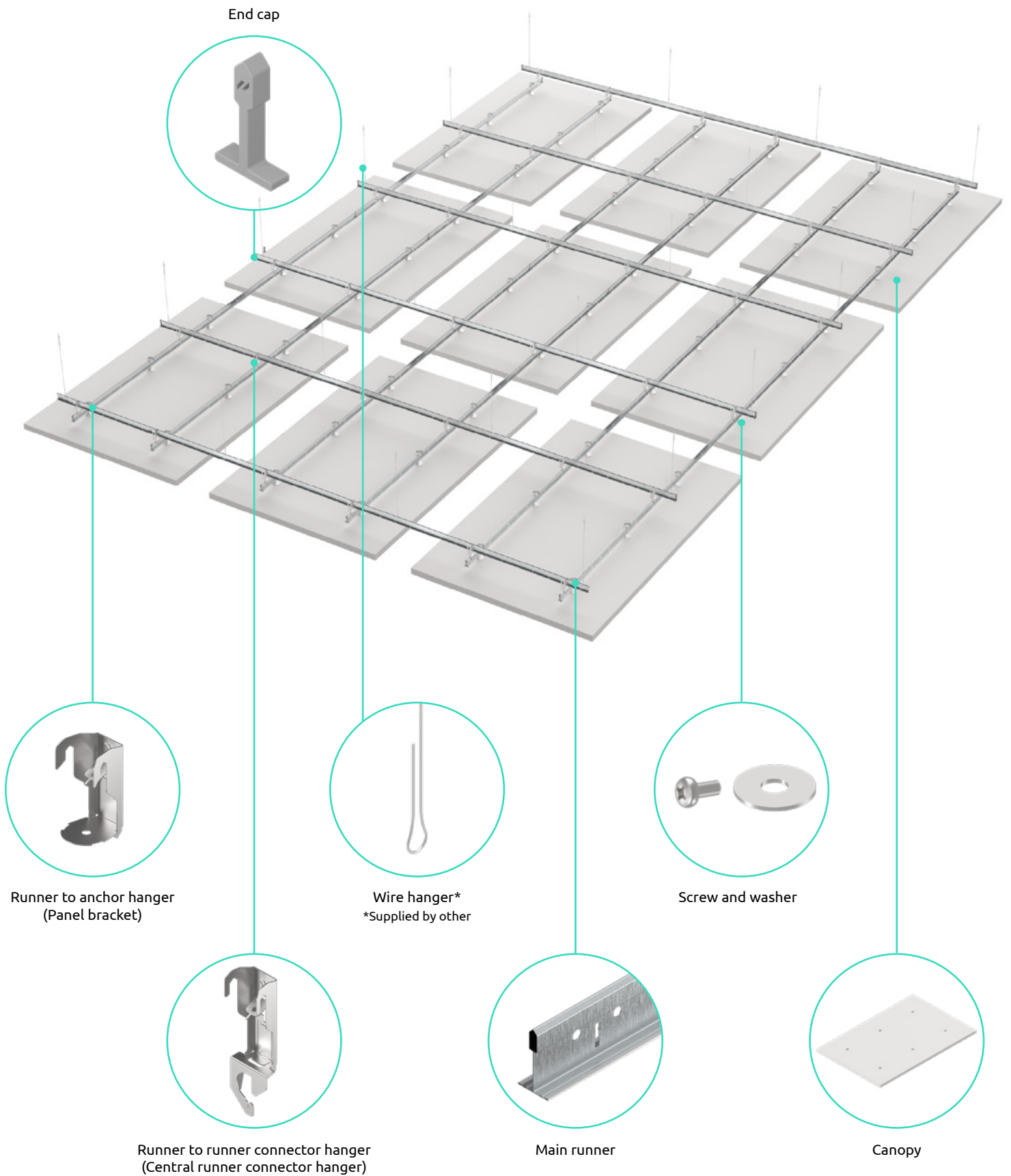

*These components are also used for Sonify Highway

Sonify Create & Highway General Requirements



Runner to anchor hanger (Panel bracket)



Runner to runner connector hanger
(Central runner connector hanger)

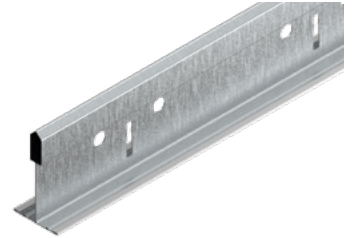

Main runner



Wire hanger*
*Supplied by other

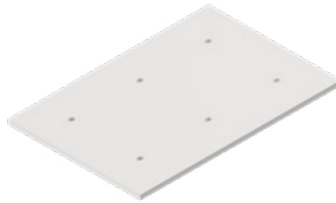

Canopy



Screw and washer

04 Required Tools



Safety

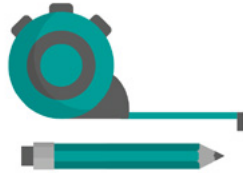

Measuring tape



Angle measure



Spirit level



Pliers

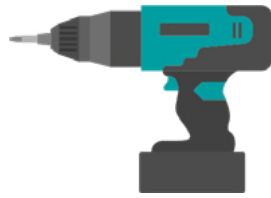

Screwdriver

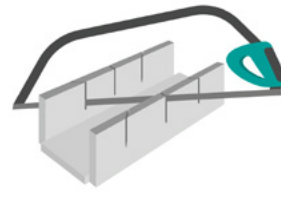

Miter Saw



Miter saw

05 Runner preparation

Generic install for each Sonify system.

Runner preparation

The runners need to be adjusted to the exact length required. They can be cut or clipped onto each other (they should always be cut in the middle between rout holes – not on a rout hole). There can be different runner lengths per configuration.

*A runner which has been cut can be re-used on the next grid row as long as one runner clip remains (see below). Cut runners with a length less than 200mm should be discarded.

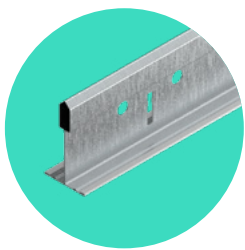

Main Runner

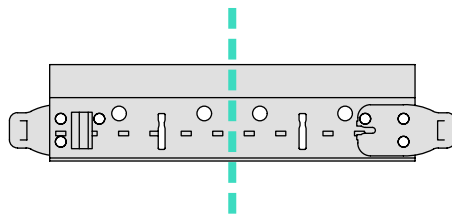

Cut

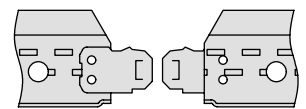

Clip

06 Wire hanger

The hangers are fixed to the soffit above the primary main runner. The last row and column distances can be irregular in some configurations.

Primary Main Runner

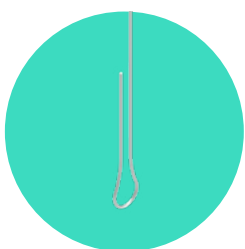

Wire Hanger*

*Supplied by other

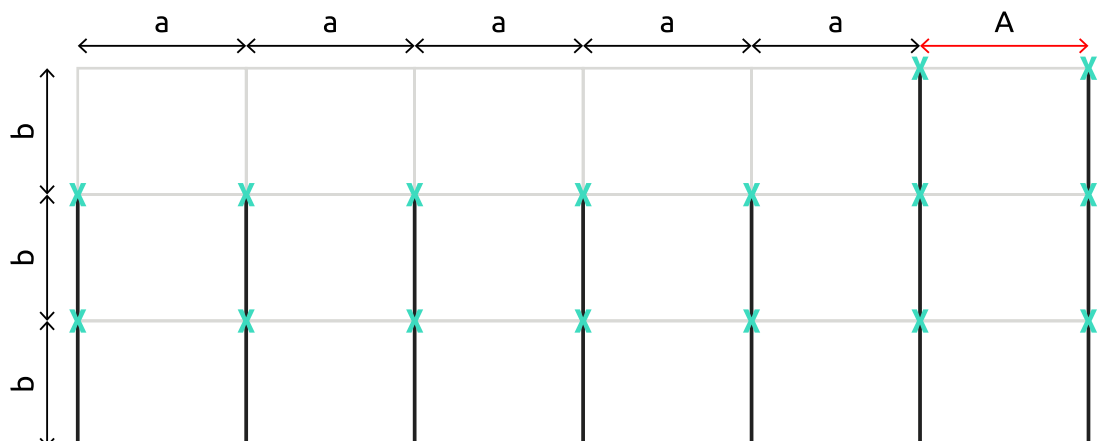

07 Suspend Primary Main Runners

Suspend the first layer of primary main runners from the wire hangers. Make sure that all runners are level and the rout holes are aligned.

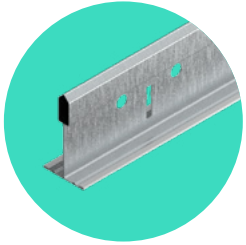

Primary Main Runner

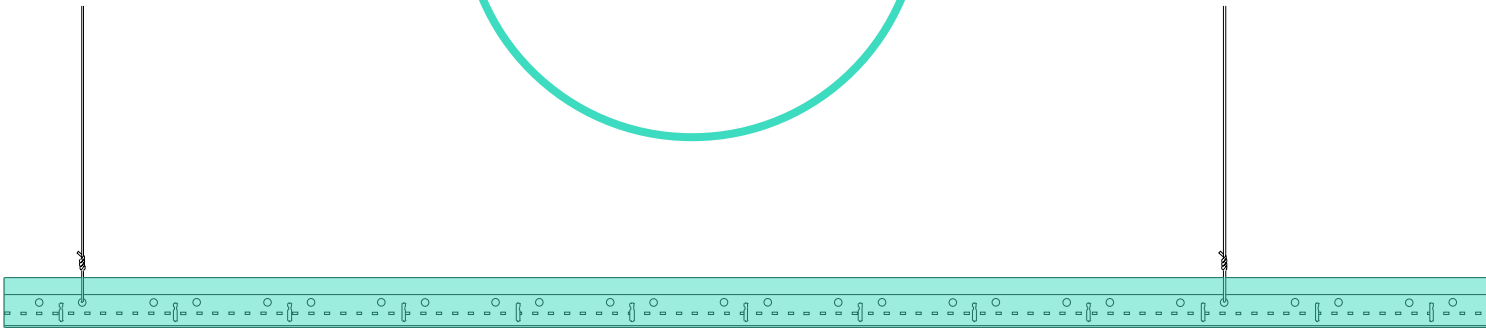
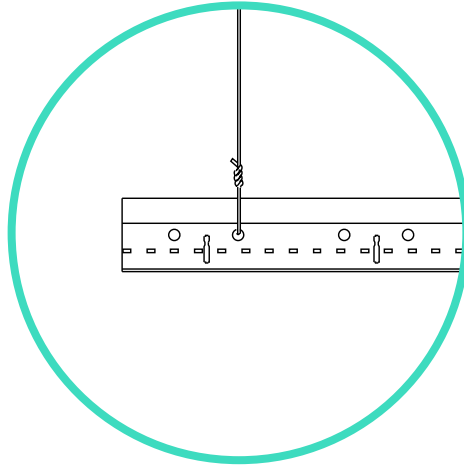

08 Runner Connector

Hook on the runner to runner connector hangers to the primary main runner and lock them by bending the lower tab around the T.



Runner to Runner
Connector Hanger

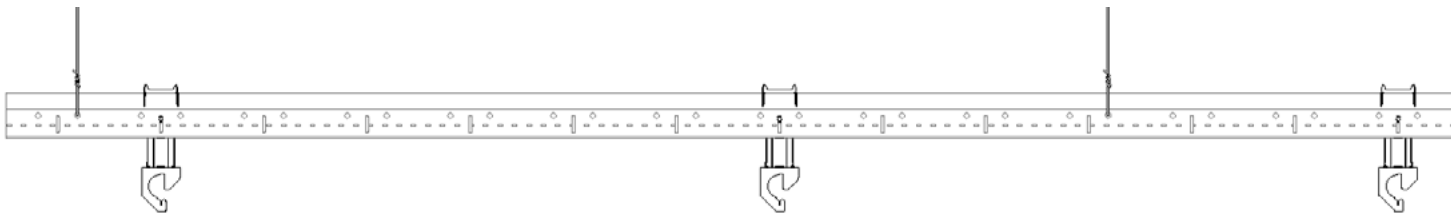
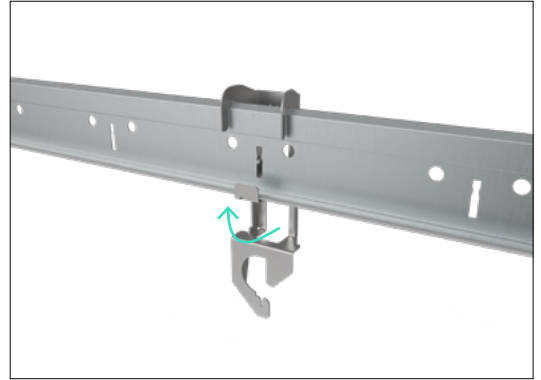
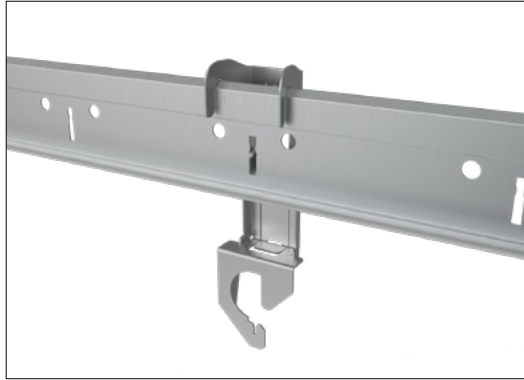

N.B. Secondary runner is not generic for the Sonify Highway runner, refer to documents provided with Sonify Highway for spacing



09 Secondary Main Runner

Suspend the secondary main runners to the lower hooks on the runner to runner connector hangers. The hook must pass through the rout hole on the secondary main runner.

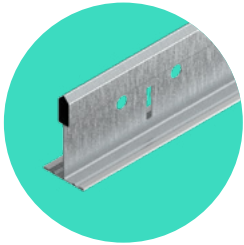

Main Runner

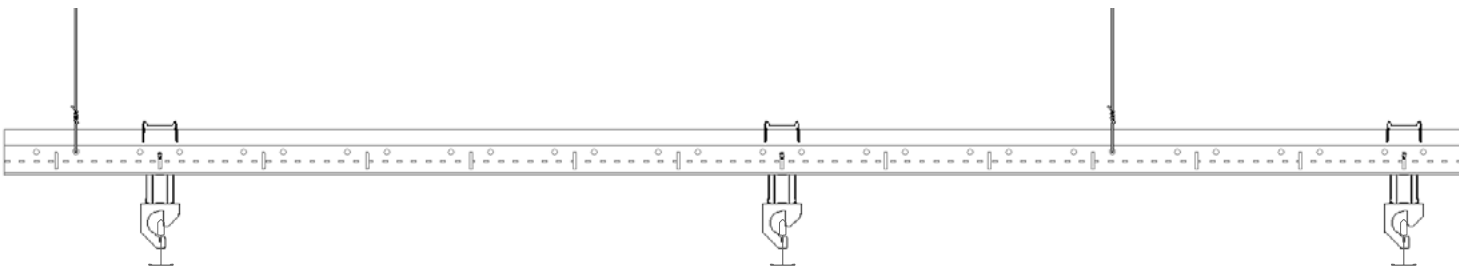
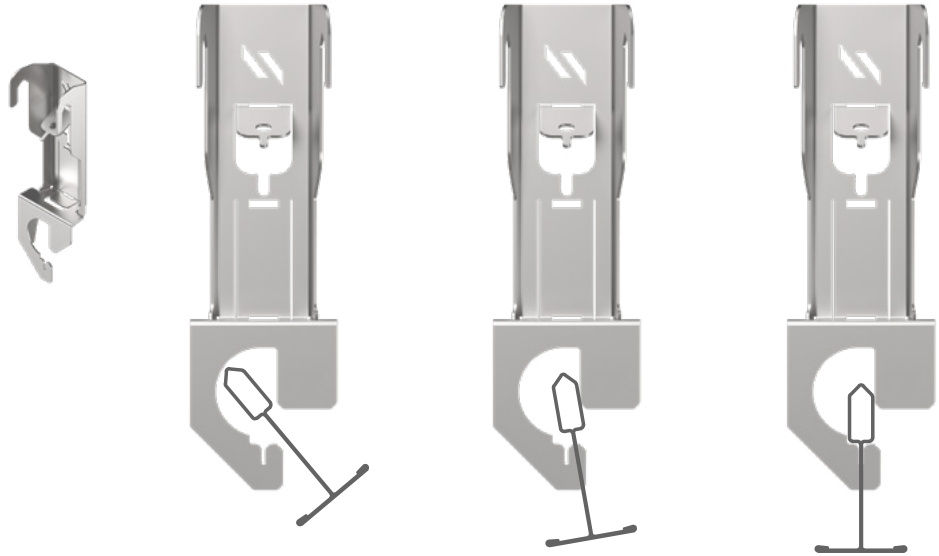

N.B. Secondary runner is not generic for the Sonify Highway runner, refer to documents provided with Sonify Highway for spacing



10 Hook on Canopy

The orientation of the runner to anchor hanger (panel bracket) depends on the final position of the specific canopy. All hooks should be facing the same direction. Make sure that their orientation works for hooking onto the secondary runners (graphic 4).

Mount the runner to anchor hangers (panel bracket) onto the pre-installed panel anchors using the screw and washer. Make sure that the screw is secure but not over tightened.



**Runner to anchor hanger
(Panel Bracket)**

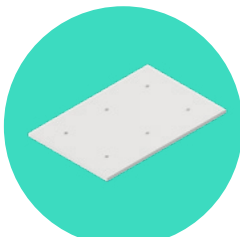
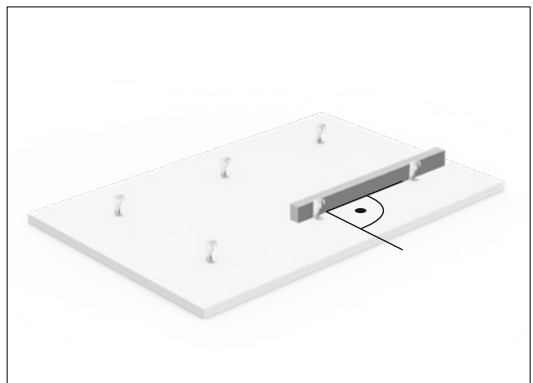
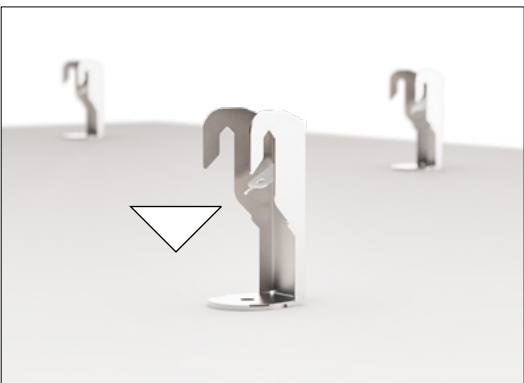

Canopy

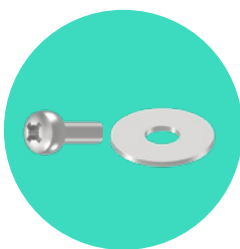
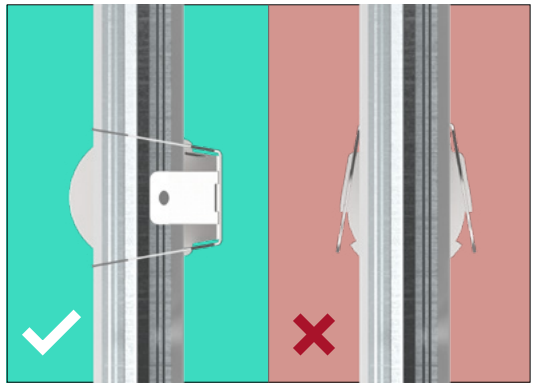
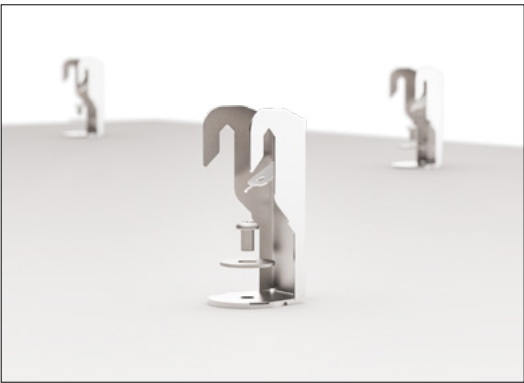

Screw & Washer

11 Canopy on Runner

Lift the canopy with its runner to anchor hangers (panel bracket) over the secondary runner. For an accurate position within the grid, the locking tabs should lock into the rout holes. The install to runner is the same for any canopy hanger set up.

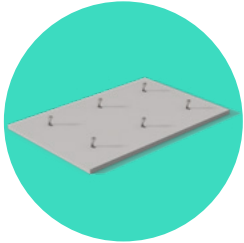

Canopy with runner
to anchor hanger
(Panel bracket)

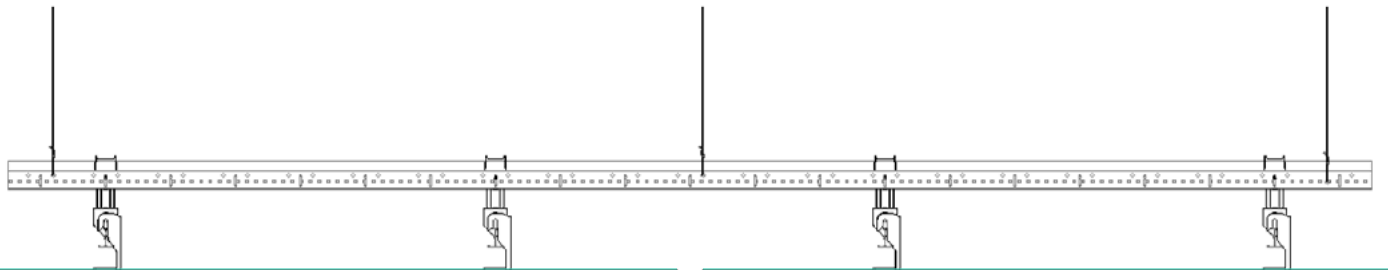
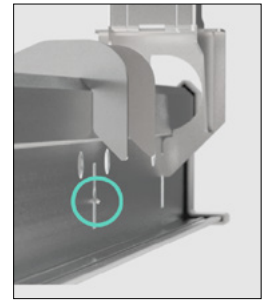
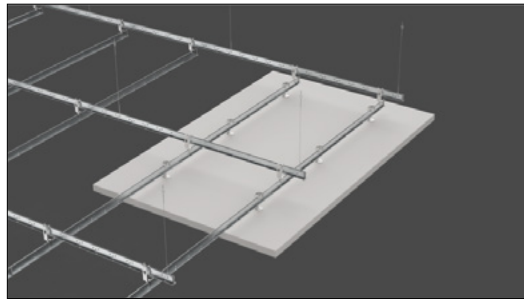

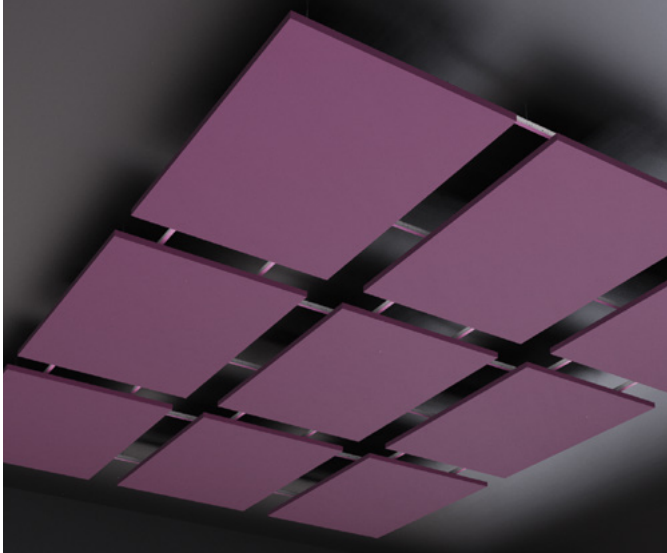

Sonify Create

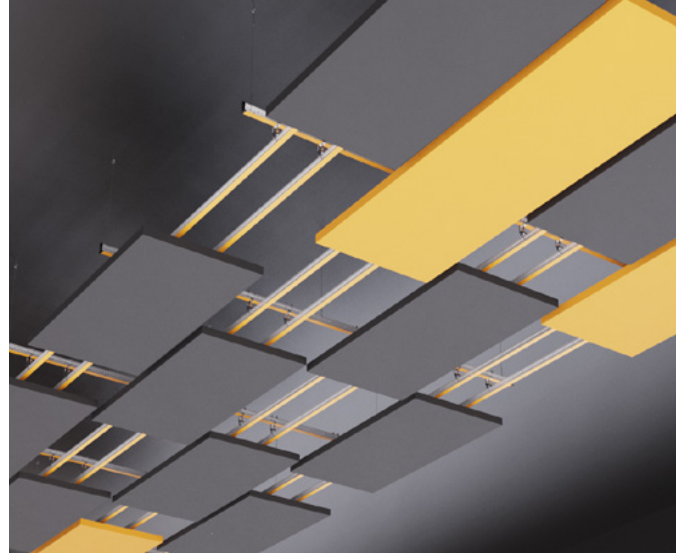

Sonify Highway

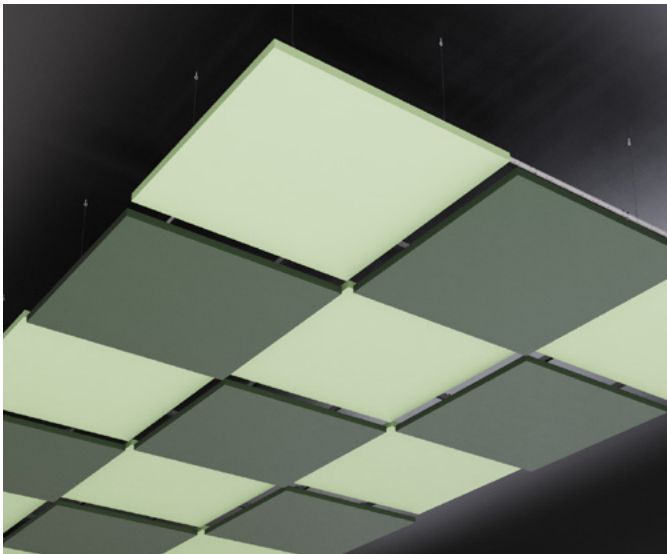

Sonify Height

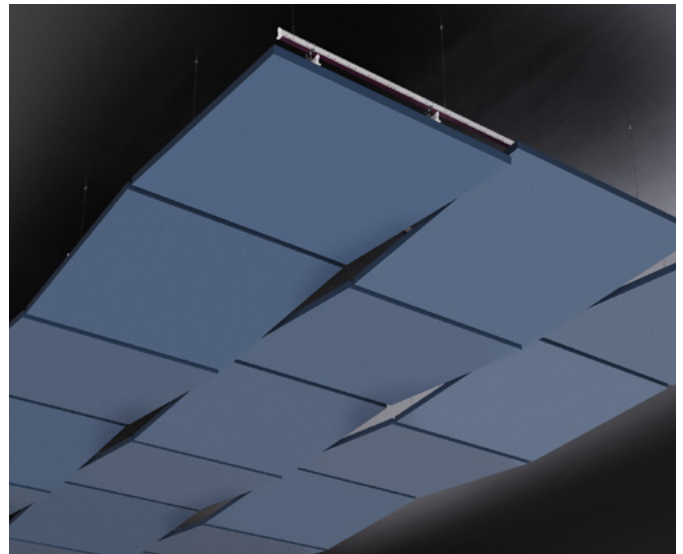

Sonify Tilt

Typical grid layout. Refer to documents for individual projects.

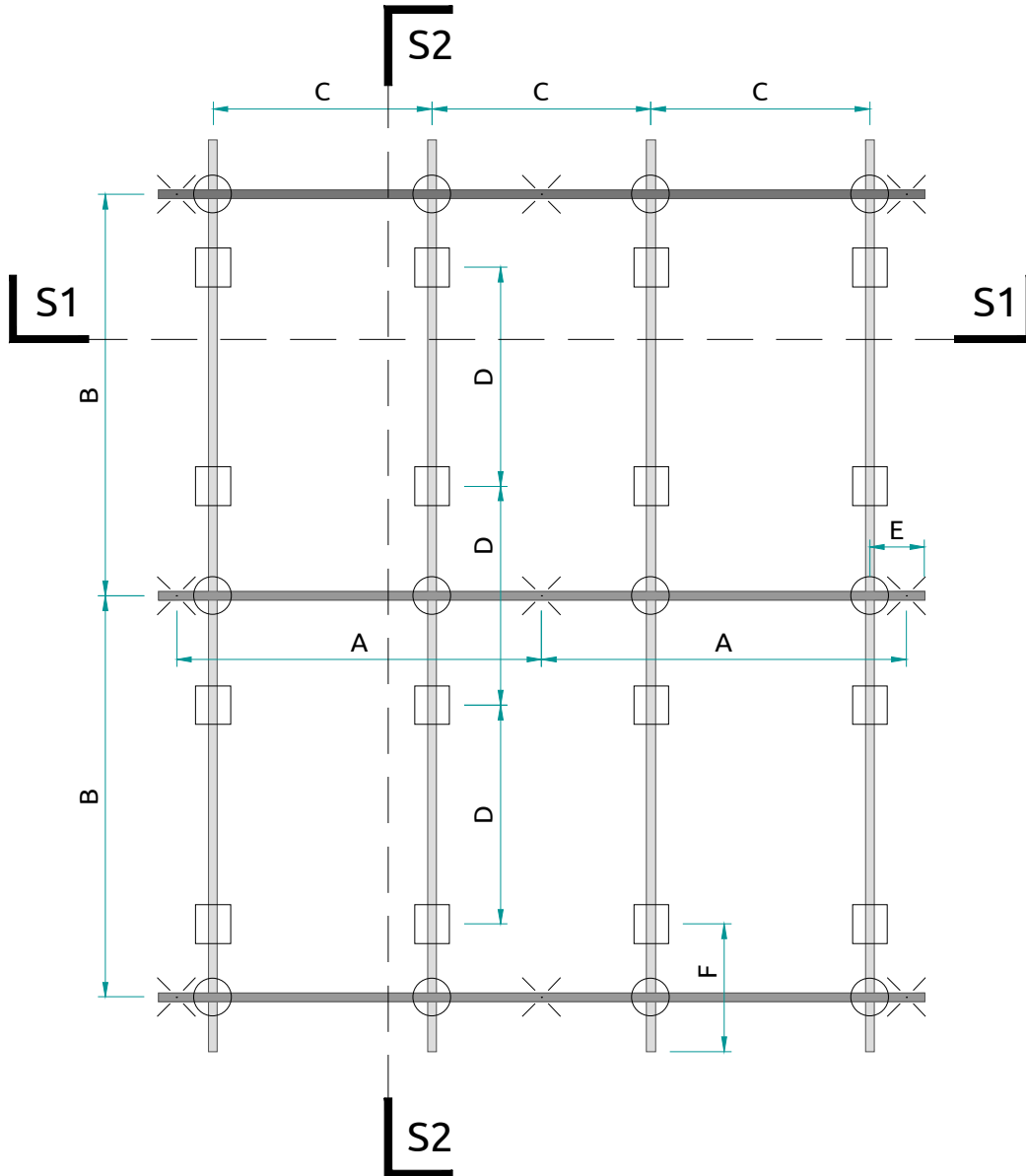



Key:

 Primary Main Runner

 Secondary Main Runner

 Runner to Runner Connector Hanger

 Runner to Anchor Hanger (Panel Bracket)

 Suspension point

A Pitch distance of suspension points = Max. 1200mm

B Pitch distance of upper primary main runner = Max. 1200mm

C Pitch distance of runner to runner connector hanger and lower secondary main runner

D Pitch distance of runner to anchor (panel bracket)

E Distance from runner to runner connector hanger to cut edge of upper primary main runner = 150mm

F Distance from panel bracket to cut edge of lower secondary main runner = 150mm

Canopy configuration

SECTION 1

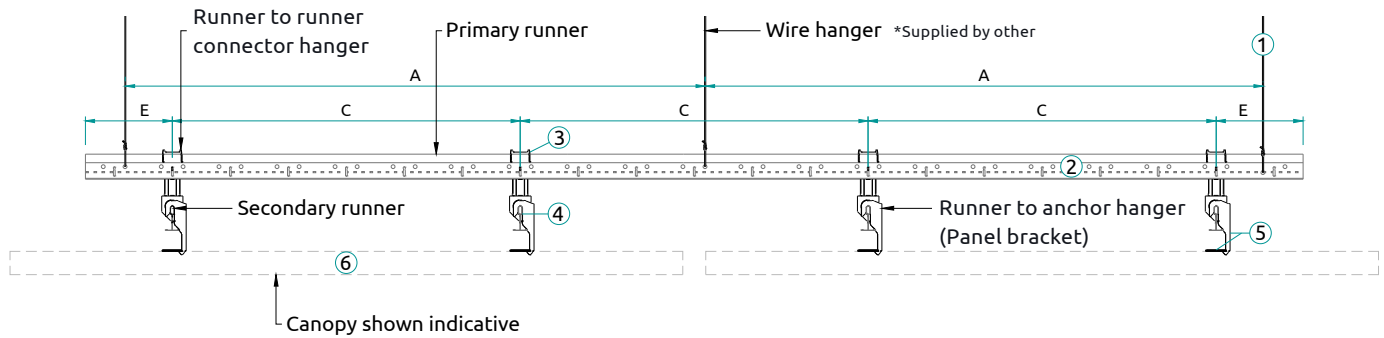

SECTION 2

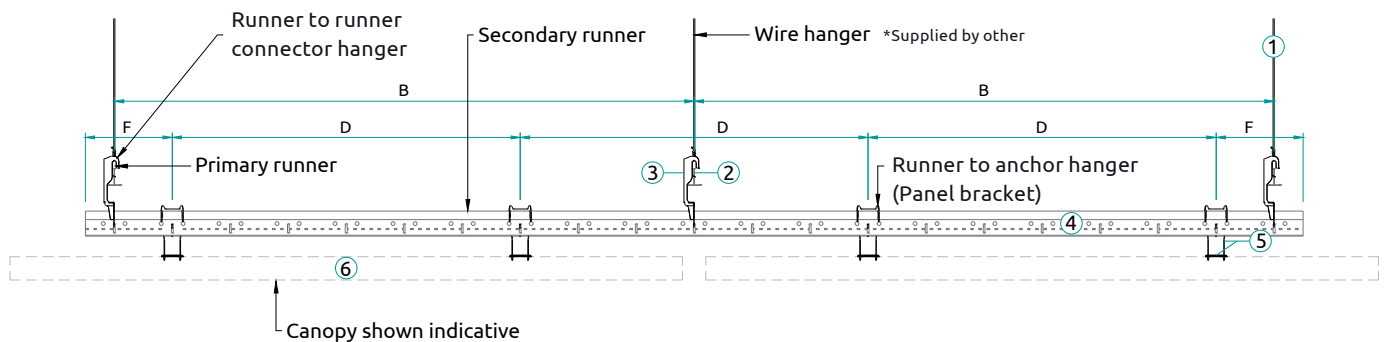

- A Pitch distance of suspension points = Max. 1200mm
- B Pitch distance of upper primary main runner = Max. 1200mm
- C Pitch distance of runner to runner connector hanger and lower secondary main runner
- D Pitch distance of panel bracket
- E Distance from runner to runner connector hanger to cut edge of upper primary main runner = 150mm
- F Distance from runner to anchor hangers (panel bracket) to cut edge of lower secondary main runner = 150mm

- 1 Locate suspension points and install hangers
- 2 Suspend upper primary main runner (length cut to suit based on layout)
- 3 Locate runner to runner connection hanger
- 4 Suspend lower secondary main runner (length cut to suit based on layout)
- 5 Attach runner to anchor hanger (panel bracket) to panel anchor in rear of canopy
- 6 Suspend canopy from secondary main runners