



Sonify Wall Absorbers

Improve the acoustic environment of a room by introducing Sonify Wall Absorbers.

Key Features

- Enhanced vertical sound absorption contributing to a total room solution
- Glued or use our wall mounted grid system for fast efficient installation
- Combine several panels to create a feature wall
- Each design is ordered using an assigned kit ID and supplied as a 'kit of parts'
- Available in a wide range of 35 colours and 7 shapes
- Outstanding acoustic performance: Reduce noise levels, increase speech intelligibility and reduce reverberation time in the space
- Ideal for a multitude of environments including hospitality, education, retail and commercial spaces

Product Wall Absorbers

Sizes (mm)

RECTANGLE

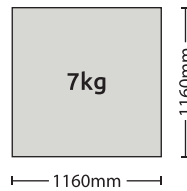
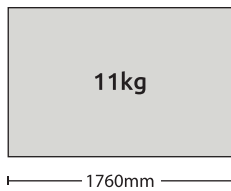
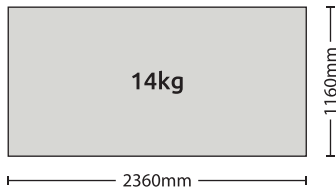

CIRCLE



HEXAGON

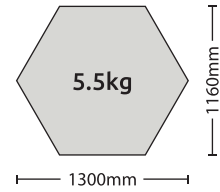

Thickness (mm)

40

Colours

Sonify White & 35 colours

Sustainability



85%



EN 13964 / E1

Acoustics



EN ISO 354
& EN ISO 11654

Practical Sound Absorption Coefficient

Distance mounted from wall (mm)	α_w	Class	NRC	Hz α_p					
				125	250	500	1000	2000	4000
25	1.00	A	1.00	0.40	0.85	1.00	1.00	1.00	1.00
flat to surface	1.00	A	0.95	0.30	0.70	1.00	1.00	1.00	1.00

Sonify Wall Absorbers tested in a white finish

Fire Reaction



Euroclass A2-s2, d0 (All colours)
EN 13501-1

Performances & Features



Wall Absorber Accessories

These components are used for the Sonify Wall Absorber grid system

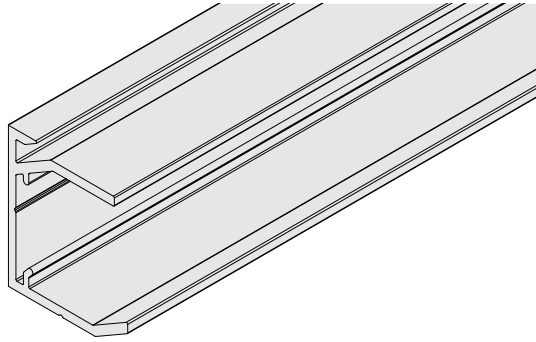

Grid Cleat*

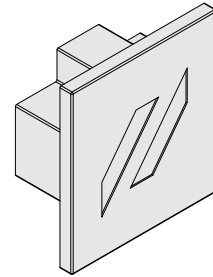

Wall Absorber Cleat End Cap

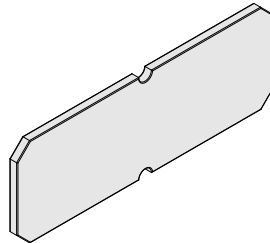

Grid Cleat joining Splice Plate



Stand-alone canopies can be glued to the wall.

Zentia recommends grab adhesive CT-1 Power Grab and Bond (PGB), by others.

If using a different adhesive, follow the manufacturers recommendations.

*Screws to be provided by contractor, suitable for fixing cleat to the wall

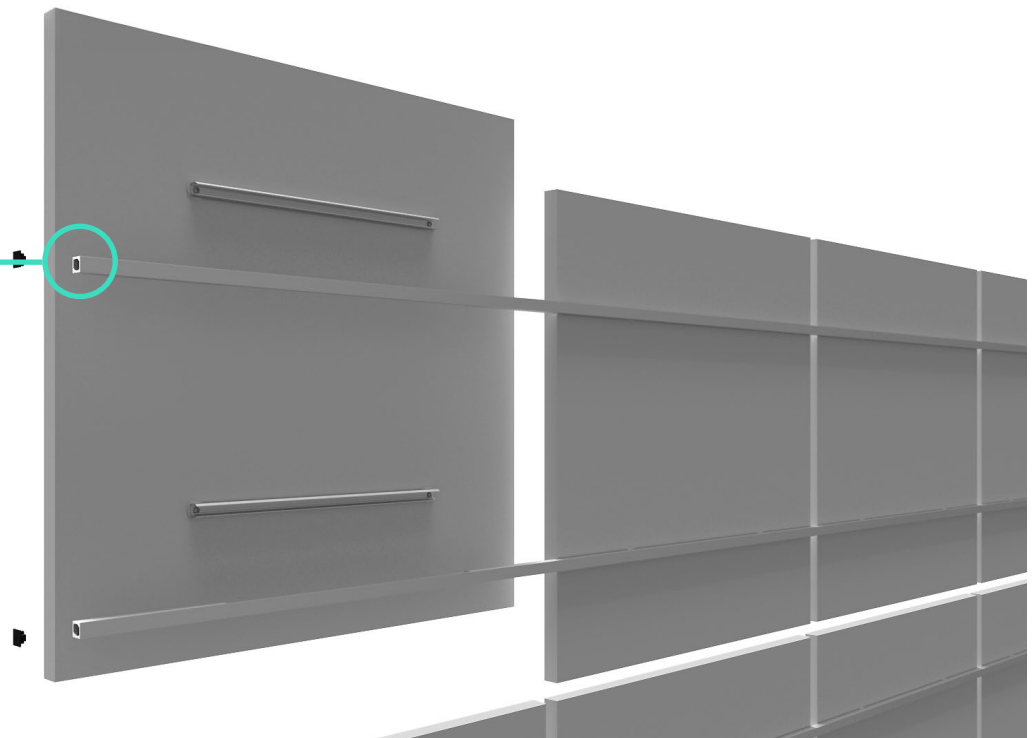

Sonify Wall Absorber grid system assembled

Colour Range

Sonify Wall Absorbers are available in Sonify White and 35 colours

 RAL 9003	 RAL 260 90 05	 RAL 130 90 10	 RAL 080 90 10	 RAL 050 90 10	 RAL 010 90 10	 RAL 340 90 05	 RAL 050 70 10
 RAL 000 85 00	 RAL 260 80 15	 RAL 130 80 30	 RAL 075 80 40	 RAL 050 80 30	 RAL 020 80 20	 RAL 340 80 20	 RAL 050 70 20
 RAL 000 65 00	 RAL 260 50 25	 RAL 140 50 30	 RAL 1003	 RAL 2009	 RAL 020 60 40	 RAL 340 60 35	 RAL 040 30 30
 RAL 000 30 00	 RAL 260 30 20	 RAL 140 30 20			 RAL 020 30 40	 RAL 340 30 30	 RAL 8004
 RAL 9005	 RAL 5015	 RAL 6037			 RAL 3020	 RAL 4006	

We recommend ordering a full colour sample prior to specification and ordering. If you would like to order a sample or have any queries about this product please contact our Technical Sales Team on **0800 371 849** or email enquiries@zentia.com.

Please note that even though great care has been taken to ensure correct colour match, colours can only be as accurate as the printing process allows.

Every monitor or mobile display has a different capability to display colours, and every individual may see these colours differently.



Order a sample



If you would like to order a sample or have any queries about this product please contact our Technical Sales Team on **0800 371 849** or email enquiries@zentia.com

TDS 147.4.09.24